



# Switch-Disconnecter-Fuse Switch-Disconnecter

Type FN



## About us

Larsen & Toubro infuses engineering with imagination. The Company offers a wide range of advanced solutions in the field of Engineering, Construction, Electrical & Automation, Machinery and Information Technology.

L&T Switchgear, a part of the Electrical & Automation business, is India's largest manufacturer of low voltage switchgear, with the scale, sophistication and range to meet global benchmarks. With over five decades of experience in this field, the Company today enjoys a leadership position in the Indian market with a growing international presence.

It offers a complete range of products including powergear, controlgear, industrial automation, building electricals & automation, reactive power management, energy meters, and protective relays. These products conform to Indian and International Standards.



Switchgear Factory, Mumbai



Switchgear Factory, Ahmednagar

# Salient Features of SDF

## Features of FN series:

- Compact design saves space
- Electrodynamic compensation
- Quad break contact system
- Full AC - 23 A rating for the complete range
- Highest fused short circuit capacity
- Quick make / Quick break / Positive break
- Clear ON / OFF indicator
- Separate arcing / Current carrying zone
- High clearance & creepages
- Separate bridge for each pole
- Maximum ground clearance
- Phase barrier & Terminal Shroud as a standard accessory
- Fuse stationary & isolated from both sides
- Direct access to mounting & terminal screws
- Generous terminal capacity
- Replaceable contacts for enhanced life
- Suitable for vertical & horizontal orientation
- Wide range of Spares & Accessories
- Handle coupling as per IS 8623

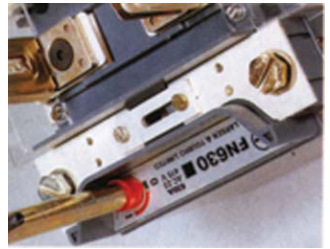

The handle coupling has the following user-friendly features.

Easy fixing of handle on panel door by two screws.

Door interlock for safety of operating personnel when switch is 'ON'. The interlock can be defeated if required.

Built-in padlocking arrangement to lock the unit in either 'ON' or 'OFF' position.

The handle coupling can take a mismatch or  $\pm 3\text{mm}$  in all directions.

Clear ON / OFF indication is provided on the switch (by a red pointer).

### Built-in neutral:

Switch-Disconnector-Fuse consists of an integral neutral, making the units suitable for 3 phase, 4 - wire application. FN 32 / 63 has switched neutral while higher ratings have isolable neutral.

### Mechanism:

This mechanism is front operated quick-make / quick-break and independent of speed of operation.

### Compact construction:

To ensure light weight low operating torque switch which saves panel space.

### Easy to maintain contacts.

Interface barriers are provided to eliminate the possibility of interface short circuit.

### Contact System:

Contact system is **QUAD BREAK**. There are no. of parallel moving contacts per pole per break. Hence, better arc quenching & more electrical life of contacts. Each pole has separate bridge carrying the moving contacts, achieving a high order of interphase separation & avoiding phase-phase flash over.

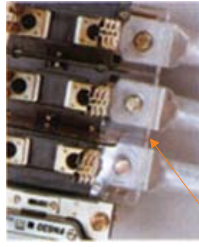

### Terminal shrouds:

The terminals can be shrouded for protection against phase-phase short circuit through an external conducting path and also for protection against accidental human contact with live terminals.

### Terminals:

To accommodate Aluminium bus bars.



### SDF Interior in Sheet Steel Enclosure:

Complete range of SDF is also available in attractive powder coated sheet steel enclosures. **FN 32 / 63 in sheet steel enclosure comes fitted with gland plate.**

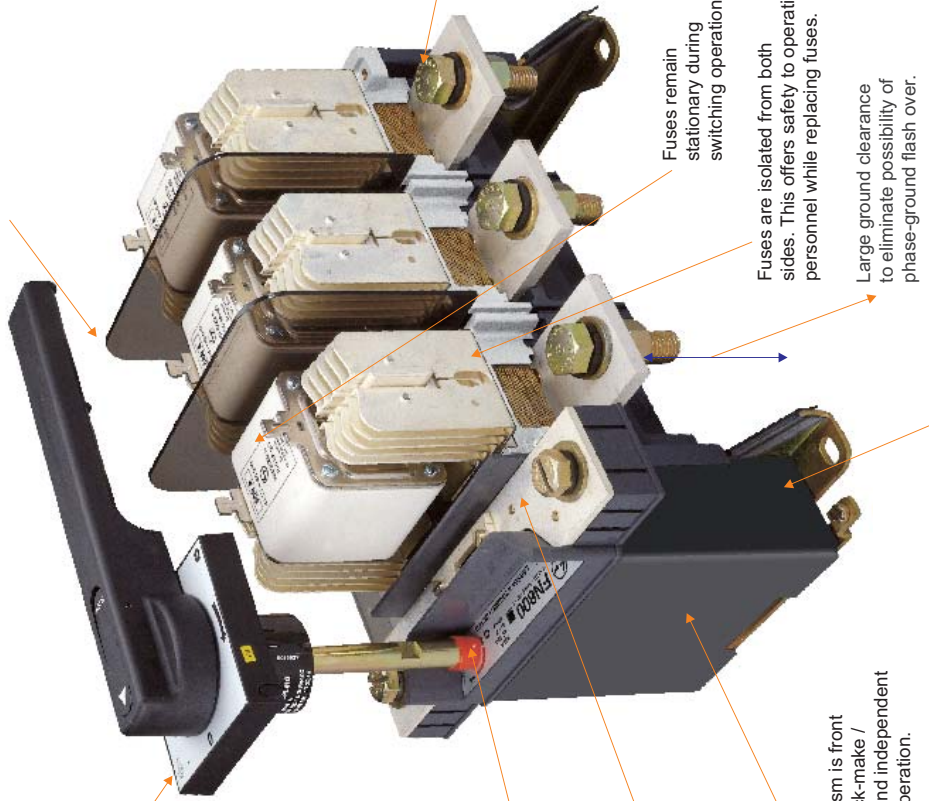

Fuses remain stationary during switching operation.

Fuses are isolated from both sides. This offers safety to operating personnel while replacing fuses.

Large ground clearance to eliminate possibility of phase-ground flash over.

The Switch-Disconnector-Fuse units can be mounted at any angle in a vertical plane.

**Switch-Disconnector-Fuse Units - Type FN**  
Conforms to IEC 60947-3, IS / IEC 60947-3

Type Designation	FN 32	FN 63	FN 100	FN 125
No. of Poles	3+Neutral	3+Neutral	3+Neutral	3+Neutral
Neutral #	Switched	Switched	Isolable	Isolable
Service temperature	-20 to 50	-20 to 50	-20 to 50	-20 to 50
Rated operational voltage (U <sub>n</sub> )	415	415	415	415
Rated insulation voltage (U <sub>i</sub> )	690	690	690	690
Rated impulse withstand voltage (U <sub>imp</sub> )	V	8	8	8
Rated frequency	V	50 - 60	50 - 60	50 - 60
Conventional enclosed thermal current at 40°C (I <sub>th</sub> )	kV	32	63	100
Rated operational current (I <sub>n</sub> ) at AC - 23 A	Hz	32	63	100
Rated making capacity (436 V, cosφ = 0.35)	A	320	630	1000
Rated breaking capacity (436 V, cosφ = 0.35)	A	256	504	800
Mechanical life (Operating cycles)	A	15000	15000	15000
Terminal capacity (main)	A	35	35	95
Terminal capacity (neutral)	mm <sup>2</sup>	35	35	50
Terminal screw	mm	M 6 x 12	M 8 x 20	M 8 x 20
Capacitor duty - 415 V, 50 - 60 Hz	kVA	14	29	45
<b>DC Rating at 220 V DC</b>				
No. of poles in series, utilization category at rated current	3, DC-23 A	3, DC-23 A	2, DC-23 A	2, DC-23 A
<b>Suitable L&amp;T fuse</b>				
$\overline{=}$ Rated fused short circuit current	kA	80**	100	100
$\square$ Rating A / Type / Size	32 / HF / 14 x 51	63 / HF / 14 x 51	100 / HN / 00	125 / HN / 00
$\overline{=}$ Rated fused short circuit current	kA	80	80	80
$\overline{=}$ Rating A / Type / Size	32 / HQ / A1L	63 / HQ / A1L	100 / HQ / A3 & A4	125 / HQ / A4

\* ..... Power factor = 0.45 as required in IS 1347 - (part 3).  
# ..... For 32, 63, 100, 125, 15000 cycles - Neutral is available as accessory.  
\*\* ..... Suitable for cylindrical fuses.

**Ordering Information**

Ordering Suffix 0000 for all \* Example: FN 32 Interior with handle \* Ordering Information - SK955180000

Description	FN 32	FN 63	FN 100	FN 125
<b>SDF suitable for DIN Fuses</b>				
Interior with handle TPN	SK95518	SK95421	SK95568	SK95001
Interior in sheet steel enclosure	SK95612	SK95613	SK95569	SK95005
Interior with handle TP			ST30287	ST27894
<b>SDF Suitable for BS Fuses</b>				
Interior with handle TPN	SK95653	SK95651	SK95570	SK95009

FN 160	FN 200	FN 250	FN 315	FN 400	FN 630	FN 800
3+Neutral	3+Neutral	3+Neutral	3+Neutral	3+Neutral	3+Neutral	3+Neutral
Isolable	Isolable	Isolable	Isolable	Isolable	Isolable	Isolable
-20 to 50	-20 to 50	-20 to 50	-20 to 50	-20 to 50	-20 to 50	-20 to 50
415	415	415	415	415	415	415
690	690	690	690	690	690	690
8	8	8	8	8	8	8
50 - 60	50 - 60	50 - 60	50 - 60	50 - 60	50 - 60	56-60
160	200	250	315	630	630	800
160	200	250	315	630	630	800
1600	2000	2500	3150	6300	6300	8000
1280	1600	2000	2520	5040	5040	6400
15000	10000	100000	10000	10000	10000	10000
185	240	240	400	2 x 400	2 X 625	2 X 625
50	120	120	240	240	400	400
M 8 X M 20	M 10 x 30	M 10 x 30	M 10 x 30	M12 x 40	M 16 x 50	M 16 x 50
57	92	115	145	240	270	270
2, DC-23 A	2, DC-23 A	2, DC-23 A	2, DC-23 A	2, DC-23 A	2, DC-23 A	2, DC-23 A
100	100	100	100	100	100	100
160 / HN / 00	200 / HN / 0	250 / HN / 1	315 / HN / 1	400 / HN / 2	630 / HN / 3	800 / HN / 3
80	80	80	80	80	80	80
160 / HQ / A4	200 / HQ / B2	250 / HQ / B2 & B3	315 / HQ / B3	400 / HQ / B4	630 / HQ / C2	

FN 160	FN 200	FN 250	FN 315	FN 400	FN 630	FN 800
SK95713	SK95418	SK95642	SK95461	SK95481	SK95521	SK95679
SK95715	SK95511	SK95681	SK95514	SK95515	SK95547	SK95705
SK95998	ST27895	ST31731	ST27897	ST27898	ST27899	ST31732
SK95714	SK95588	SK95682	SK95590	SK95591	SK95592	

# Technical Data

## Switch-Disconnector - Type FN Conforms to IEC 60947-3, IS / IEC 60947-3

Type Designation	FN 200	FN 250	FN 315	FN 400	FN 630	FN 800	FN 1000	FN 1000H
No. of Poles	3+Neutral	3+Neutral	3+Neutral	3+Neutral	3+Neutral	3+Neutral	3+Neutral	3+Neutral
Neutral	Isolable	Isolable	Isolable	Isolable	Isolable	Isolable	Isolable	Isolable
Service temperature	-20 to 50	-20 to 50	-20 to 50	-20 to 50	-20 to 50	-20 to 50	-20 to 50	-20 to 50
Rated operational voltage (U <sub>n</sub> )	415	415	415	415	415	415	415	415
Rated insulation voltage (U <sub>i</sub> )	690	690	690	690	690	690	690	690
Rated impulse withstand voltage (U <sub>imp</sub> )	8	8	8	8	8	8	8	8
Rated frequency	50 - 60	50 - 60	50 - 60	50 - 60	50 - 60	50 - 60	50 - 60	50 - 60
Conventional enclosed thermal current at 40°C (I <sub>th40</sub> )	200	250	315	400	630	800	1000	1000
<b>Rated operational current (I<sub>n</sub>)</b>								
AC 20 A utilization category	200	250	315	400	630	800	1000	1000
AC 21 A utilization category	200	250	315	400	630	800	1000	1000
AC 22 A utilization category	200	250	315	400	630	800	1000	1000
AC 23 A utilization category	200	250	315	400	630	800	1000	1000
Rated making capacity (436 V, cosφ = 0.35)	2000	2500	3150	4000	6300	8000	10000	10000
Rated breaking capacity (436 V, cosφ = 0.35)	1600	2000	2520	3200	5040	6400	8000	8000
Capacitor duty - 415 V 50 - 60 Hz	92	115	145	175	270	270	270	270
Mechanical life (Operating cycles)	10000	10000	10000	10000	10000	10000	6000	6000
Terminal capacity (main)	240	400	400	2 x 400	2 x 625	2 x 625	2 x 625	2 x 625
Terminal capacity (neutral)	120	120	120	240	400	400	400	400
Terminal screw	M 10 x 30	M 10 x 30	M 10 x 30	M 12 x 40	M 16 x 50	M 16 x 50	M 16 x 50	M 16 x 50
Short circuit withstand current (without fuses) for 1 sec	6	10	14	14	20	20	25	50
<b>DC Rating at 220 V DC</b>								
No. of poles in series, utilization category at rated current	2, DC-23 A	2, DC-23 A	2, DC-22 A	2, DC-22 A	2, DC-22 A	2, DC-22 A	2, DC-22 B	

## Ordering Information

Ordering Suffix 0000 for all \* Example: FN 32 Interior with handle \* Ordering Information - SK955410000

Description	FN 200	FN 250	FN 315	FN 400	FN 630	FN 800	FN 1000	FN 1000H
Interior with handle TPN	SK95607	SK95608	SK95609	SK95610	SK95611	SK95551	SK95710	SK95992

Description	FN 32	FN 63	FN 100	FN 125
Interior with handle TPN	SK95541	SK95540	SK95571	SK95405

# Spares & Accessories

Wide range of spares & accessories are available for Switch-Disconnecter-Fuse units type FN.

## Accessories

### Switched Neutral:

In FN 32 / 63 Switched-Neutral pole is an integral part of the Switch-Disconnecter-Fuse. For higher ratings, a double break, site-fitted switched neutral pole can be provided. This is operated by the main mechanism.



### Terminal Shroud:

The terminals can be shrouded for protection against phase-short circuit through an external conducting path and against accidental human contact with live terminals.

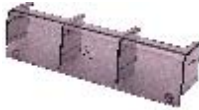

### Mechanical Interlock Kit:

Two Switch-Disconnecter-Fuse units can be interlocked by mechanical interlock kit. After interlocking, the following three positions are possible:

- SDFU 1 in ON position SDFU 2 in OFF position
- SDFU 2 in ON position SDFU 1 in OFF position
- Both SDFUs in OFF position hence two mechanically interlocked SDFUs can be used as a changeover switch



### Castell Interlock:

Switch-Disconnecter-Fuse units can be locked on OFF position with help of castell interlock. Castell interlock can also be used to interlock two SDF units. (Different variety of locks are available).



### Shaft Extension Kit:

Shaft length can be increased with shaft extension kit.



### Fuse Puller:

A fuse puller is provided to facilitate easy & safe removal of fuses.



### Handle Coupling (type A & B):

Irrespective of the switch orientation (vertical or horizontal), operation in any of the four quadrants is possible by selecting right handle coupling (Refer table on next page).

### Auxiliary Contacts:

1 NO + 1 NC auxiliary contact is available as an accessory. This can be suitably wired in the control circuit.

- Rated operational current  $I_o$  (AC - 15) - 4 A
- Rated operational voltage  $U_o$  - 415 V



## Spares

### Moving Contacts:

Moving contacts are available for ranges FN 100 to FN 800. One set of moving contact spare contains, spring, guide & moving contact.



### Front Housing assembly:

Complete front housing assembly is available from FN 100 to FN 800.











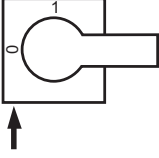
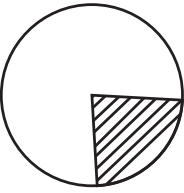
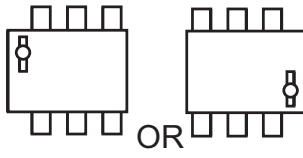

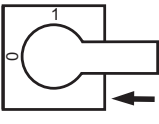
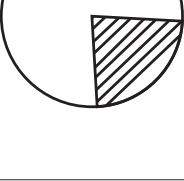
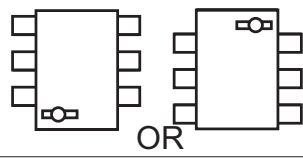

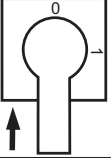
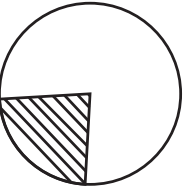
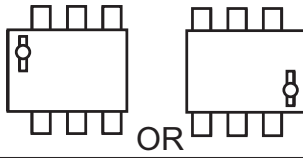

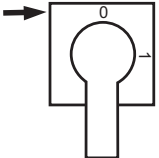
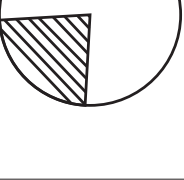
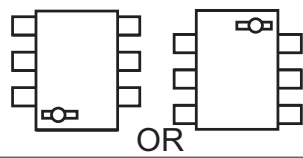

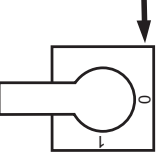
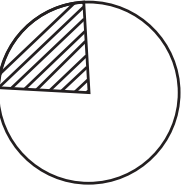
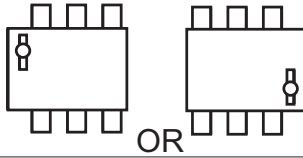
## Spares & Accessories for FN Range - Ordering Information

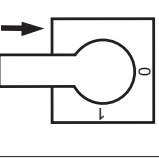
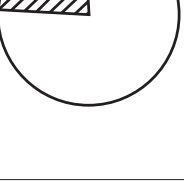
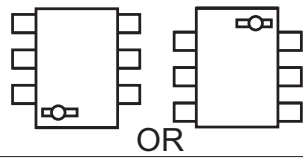
Versions		FN 32 / 63	FN 100	FN 125/160	FN 200	FN 250	FN 315	FN 400	FN 630	FN 800	FN 1000/1000H	
Spares	Moving Contact	Not Available	SK91373		SK91374	SK91375	SK91376	SK91377	SK91378	SK91379	Not Available	
	Front Housing Assembly	Not Available	ST31677	ST31678	ST31679	ST31729	ST31681	ST31682	ST31683	ST31730	Not Available	
Accessories	Terminal Shroud Kit	SK91190	SK91137		SK91335		SK91346		SK91347			
	Switched Neutral Kit	Built-in	SK95233		SK95516		SK95517		SK95546			
	Aux. Contact (1 NO + 1 NC)	SK91302	SK91328		SK91329		SK91330					
	Handle Coupling (Type - A)	SK91257	SK91258					SK91259				
	Handle Coupling (Type - B)	SK91277	SK91278					SK91279				
	Handle Coupling (Type - CE)	SK91337	Not Available									
	Fuse Puller	SK91185	SF90126									
	Shaft Extension Kit	Not Available	SK95600				SK91331					
	Mechanical Interlock Kit	Not Available	SK95232				SK95545					
Castell Lock (Type A-Type D)	Not Available	SK00333 - SK00336				SK00345 - SK00348						

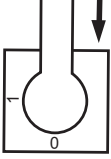
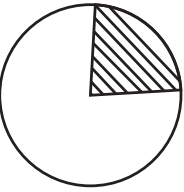
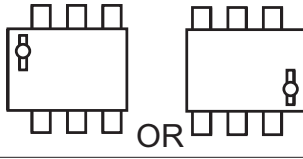
# Selection of Handle

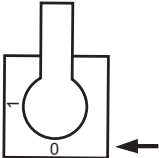
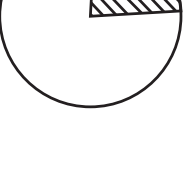
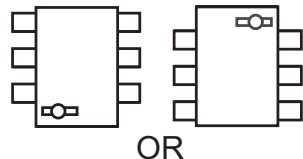
Seen from front of the door

Sr. No.	Handle (off) Position	Operating Quadrant (hand)	Switch Orientation	Door Cut-out	Handle Coupling Type
1					A
2					B
3					B
4					A
5					A
6					B
7					B
8					A

Note : Arrow (←) indicates position of Interlock Defeat Key  
 Type A : supplied as standard with all S-D-Fs  
 Type B : supplied on request



# Overall Dimensions

## Switch-Disconnecter-Fuse (suitable for DIN type fuses)

### SDF - FN 32 / 63

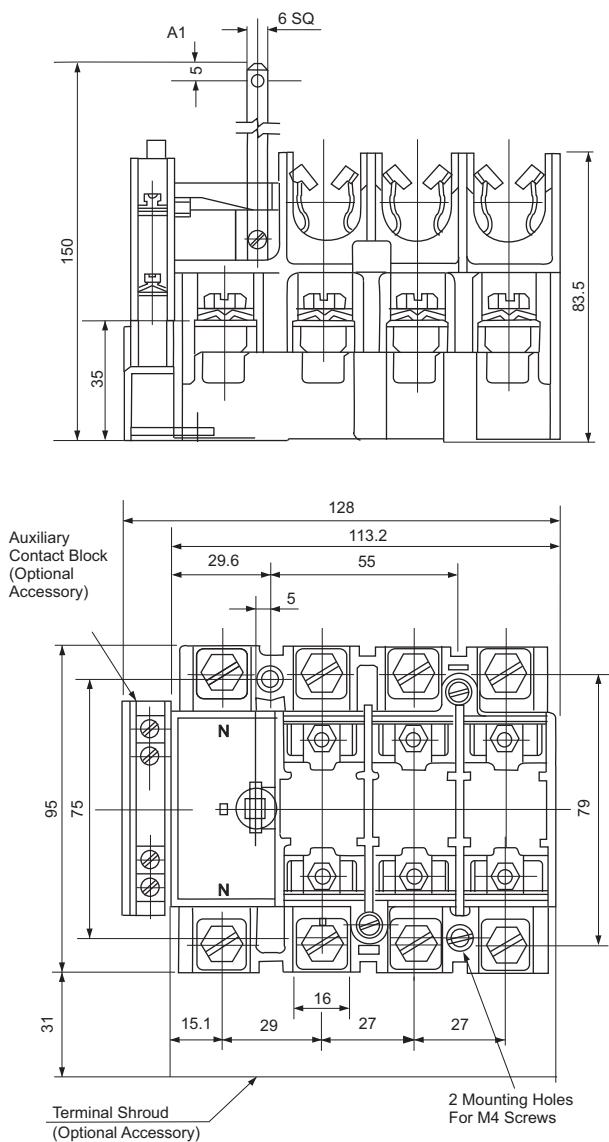

### Assembly of Handle Coupling on Door - FN 32 / 63

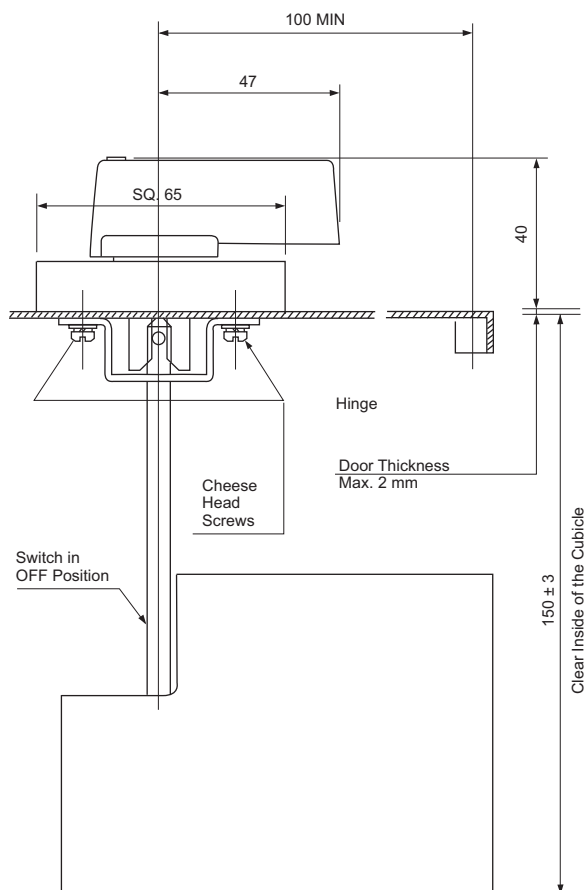

## Drilling details FN 32 / 63

Drilling details on door for mounting handle coupling seen from front of the door

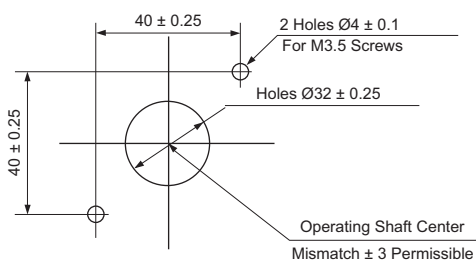

Drilling details on base plate for mounting switch seen from front of the door

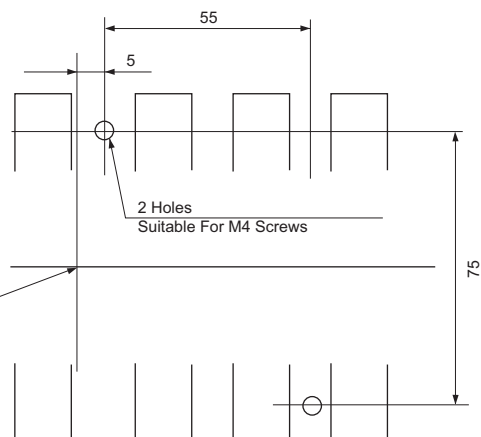

Note : All dimensions are in mm.

## Switch-Disconnecter-Fuse (suitable for DIN type fuses)

### FN 100 / 125 / 160

Type	A	B
FN 100 / 125	154	20
FN 160	164	25

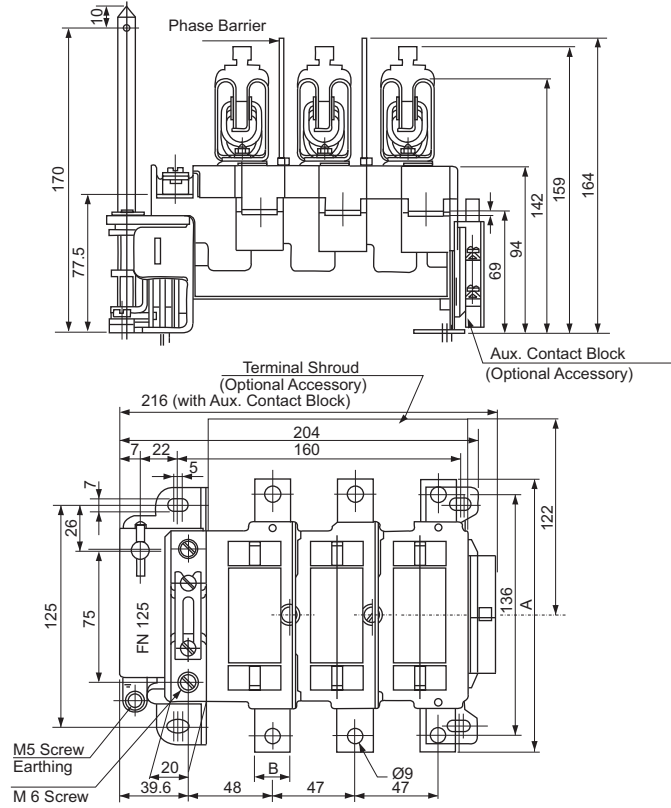

### FN 200 / 250

Type	A	B	C	D
FN 200	190	162.5	178	187.5
FN 250	206	108.5	194.5	204

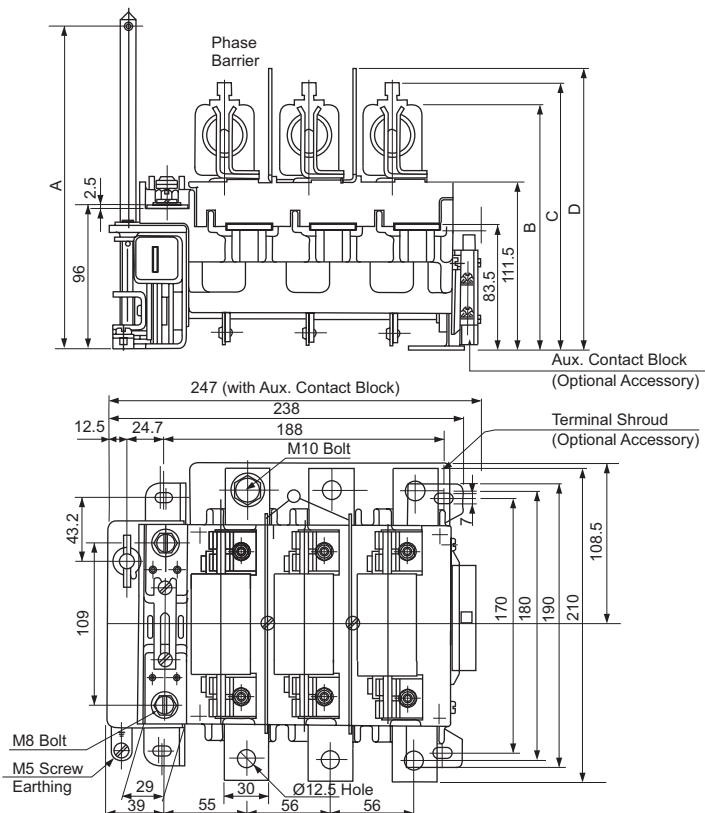

Note : All dimensions are in mm.

# Overall Dimensions

## Assembly of Handle Coupling on Door FN 100 / 125 / 160 / 200 / 250

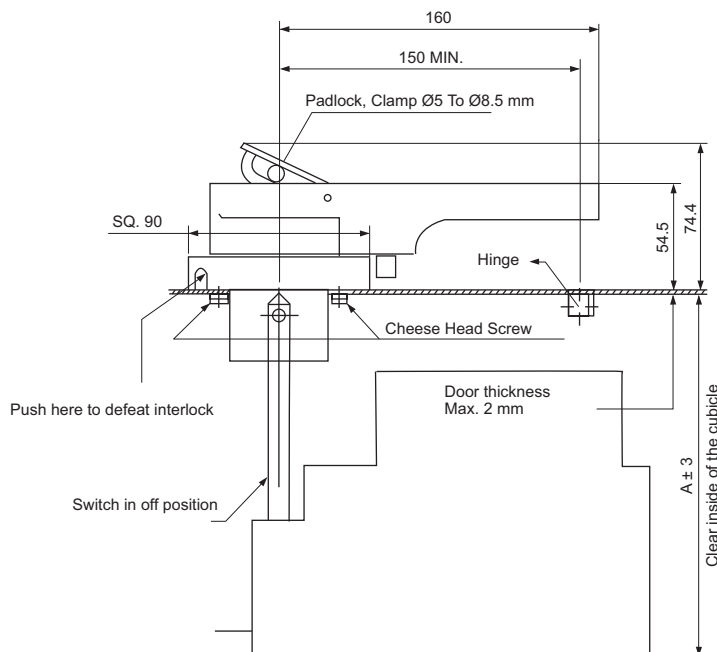

Dimension	FN 100 / 125 / 160	FN 200	FN 250
A	180	200	216

## Drilling details FN 100 / 125 / 160 / 200 / 250

Drilling details on door  
for mounting handle coupling  
seen from front of the door

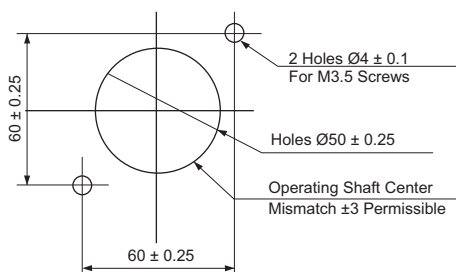

Drilling details on base plate  
for mounting switch  
seen from front of the door

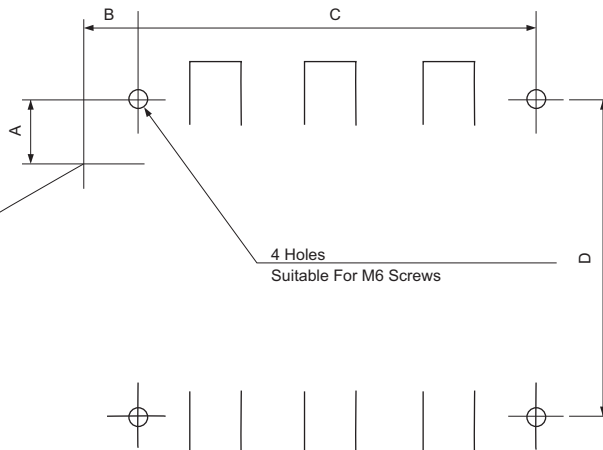

Type	A	B	C	D
FN 100 / 125 / 160	26	22	160	125
FN 200	43.2	24.7	188	170
FN 250	43.2	24.7	188	170

Note : All dimensions are in mm.

## Switch-Disconnecter-Fuse (suitable for DIN type fuses)

### FN 315 / 400

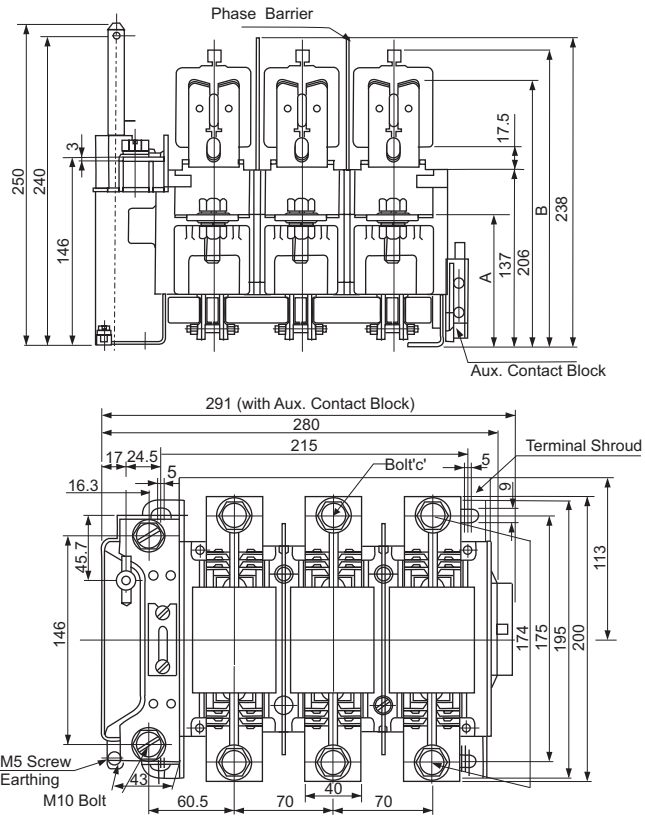

Type	A	B	C
FN 315	103	220	M10
FN 400	102	228	M12

### FN 630 / 800

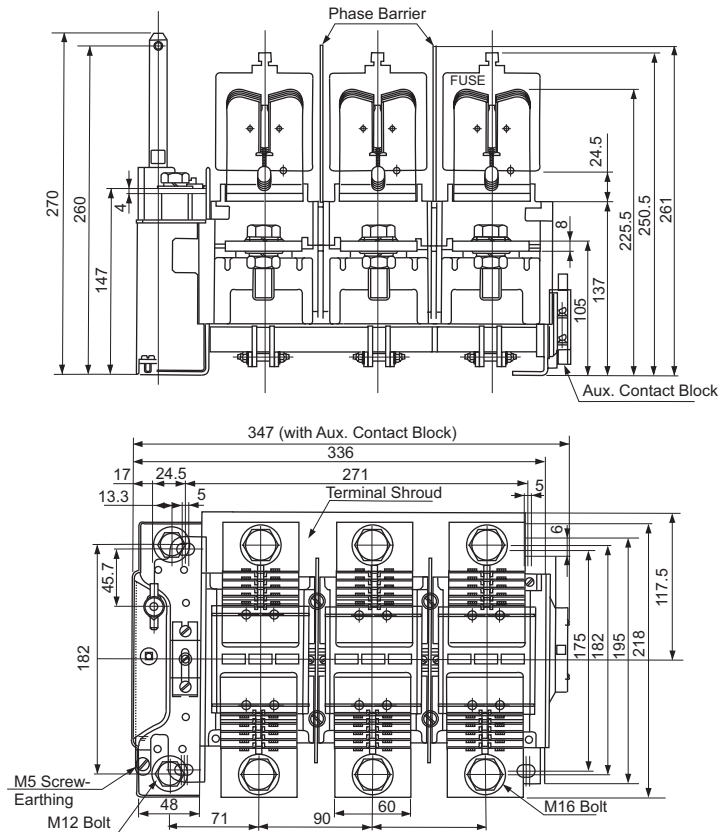

Type	A
FN 630	6
FN 800	8

Note : All dimensions are in mm.

# Overall Dimensions

## Assembly of Handle Coupling on Door FN 315 / 400 / 630 / 800

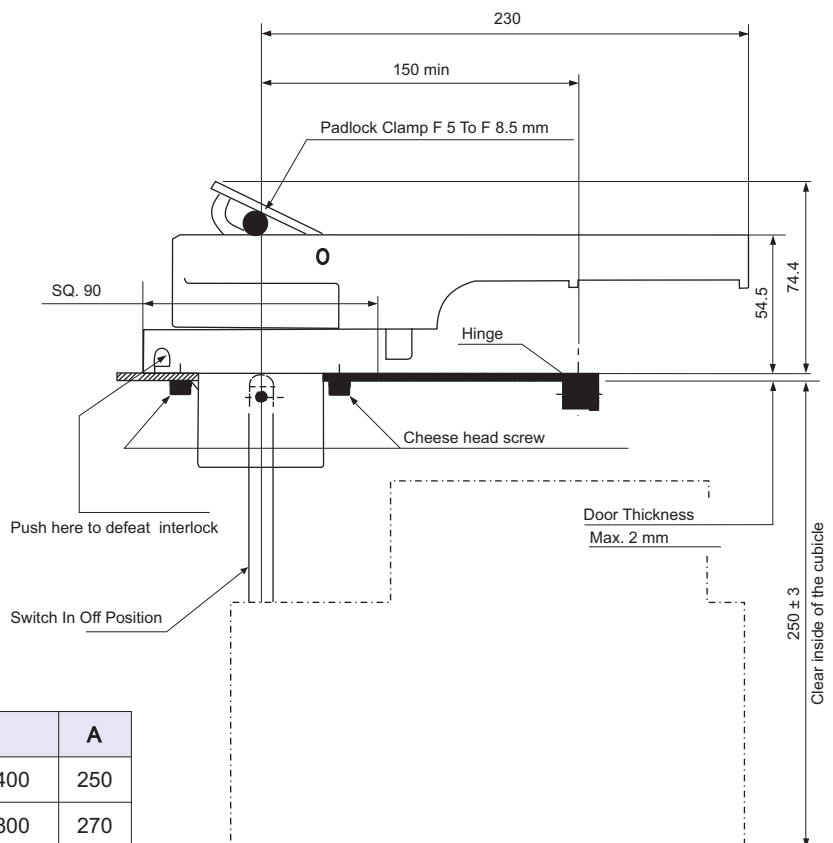

Type	A
FN 315 / FN 400	250
FN 630 / FN 800	270

## Drilling details FN 315 / 400 / 630 / 800

Drilling details on door for mounting handle coupling seen from front of the door

Drilling details on base plate for mounting switch seen from front of the door

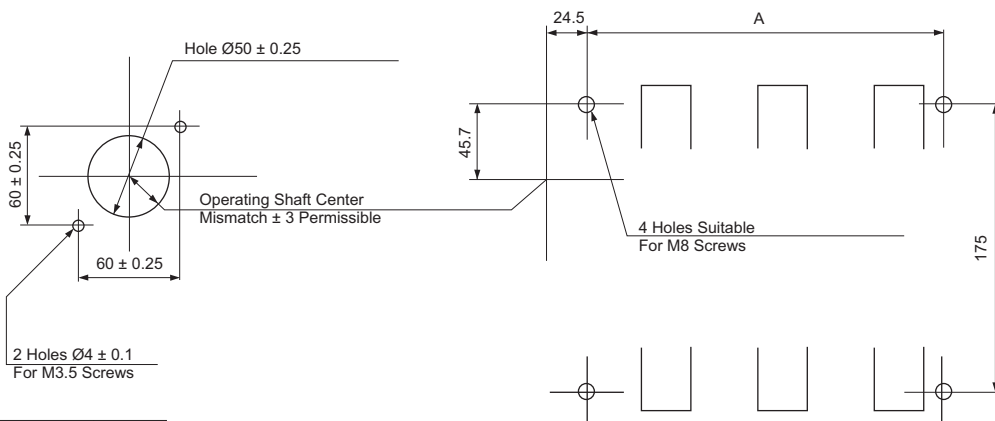

Type	A
FN 315 / FN 400	215
FN 630 / FN 800	271

Note : All dimensions are in mm.

## FN in Sheet Steel Enclosure

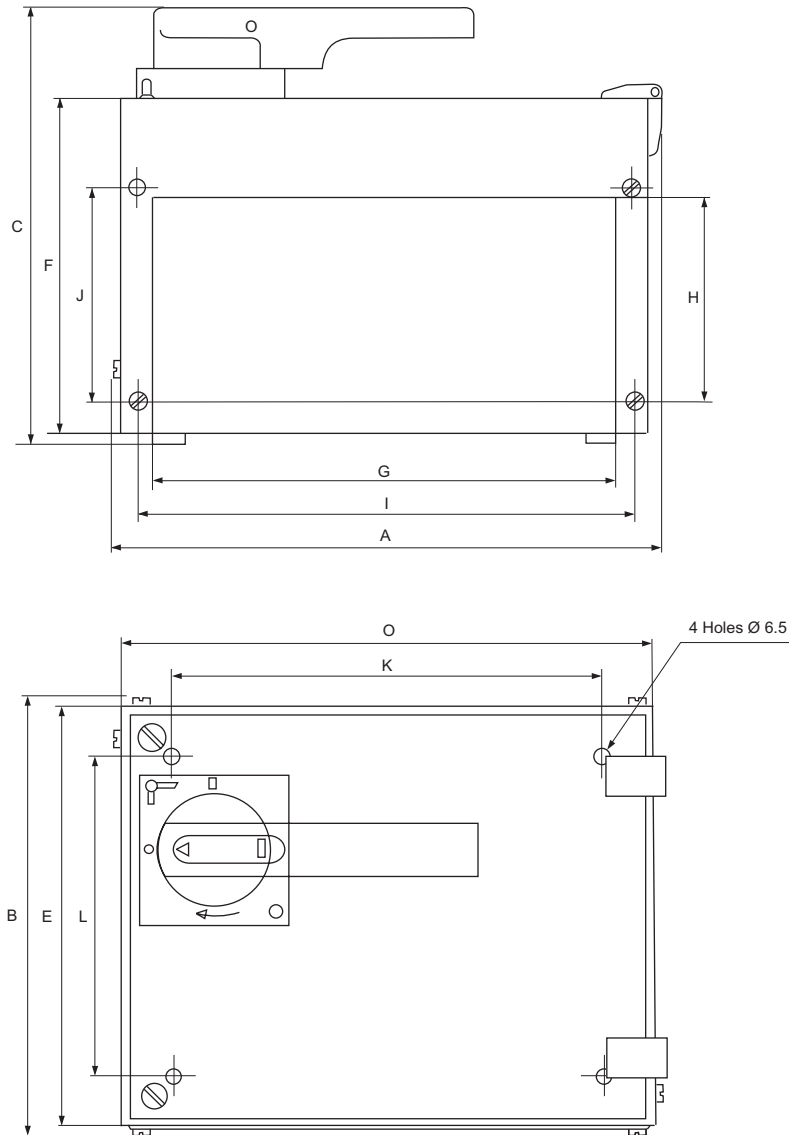

Type	Extreme overall dimension			Basic enclosure dimension			Cutout for Cables		GI and Plate mounting dimension		Enclosure mounting dimension	
	A	B	C	D	E	F	G	H	I	J	K	L
FN 32 / 63	245	238	196	230	226	153	190	73	210	80	170	165
FN 100 / 125 / 160	288	265	245	273	253	183	233	104	253	110	213	193
FN 200	335	265	265	320	253	203	280	124	300	130	260	193
FN 250	335	265	281	320	253	219	280	124	300	130	260	193
FN 315 / 400	365	265	315	350	253	253	310	185	330	191	300	203
FN 630 / 800	421	285	337	406	273	273	366	185	386	191	346	223

Note : All dimensions are in mm.

# Overall Dimensions

## Switch-Disconnecter-Fuse (suitable for BS type fuses)

### FN 32 / 63

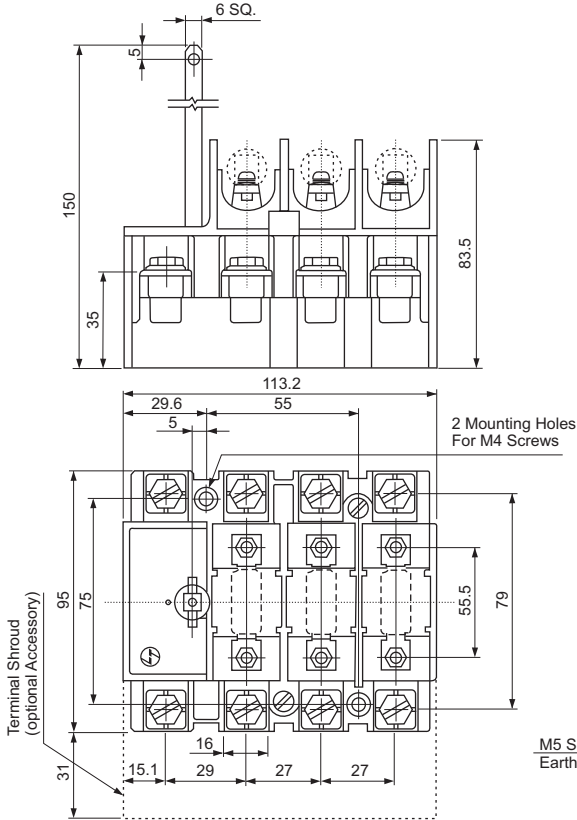

### FN 100 / 125

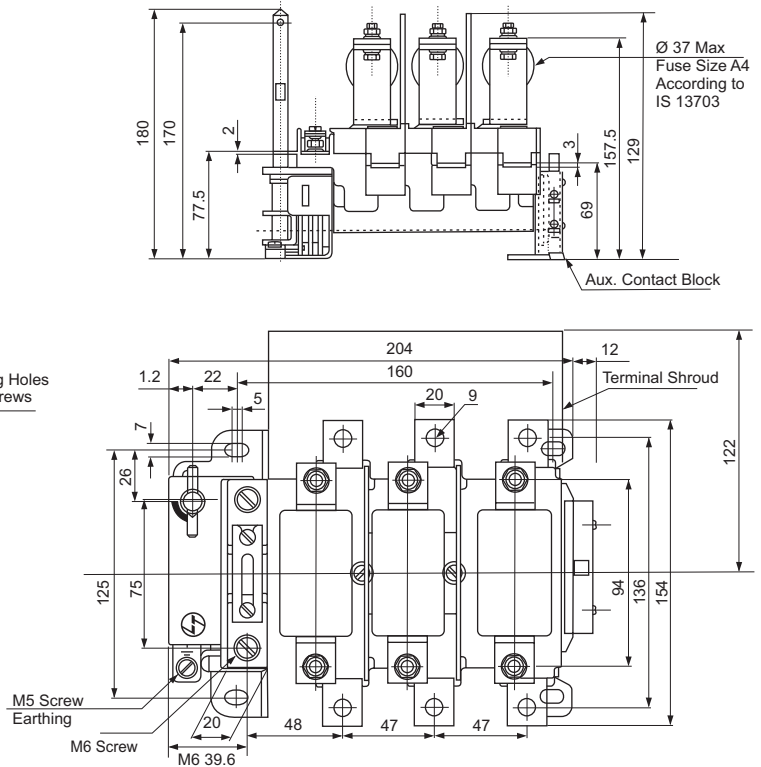

### FN 200 / 250

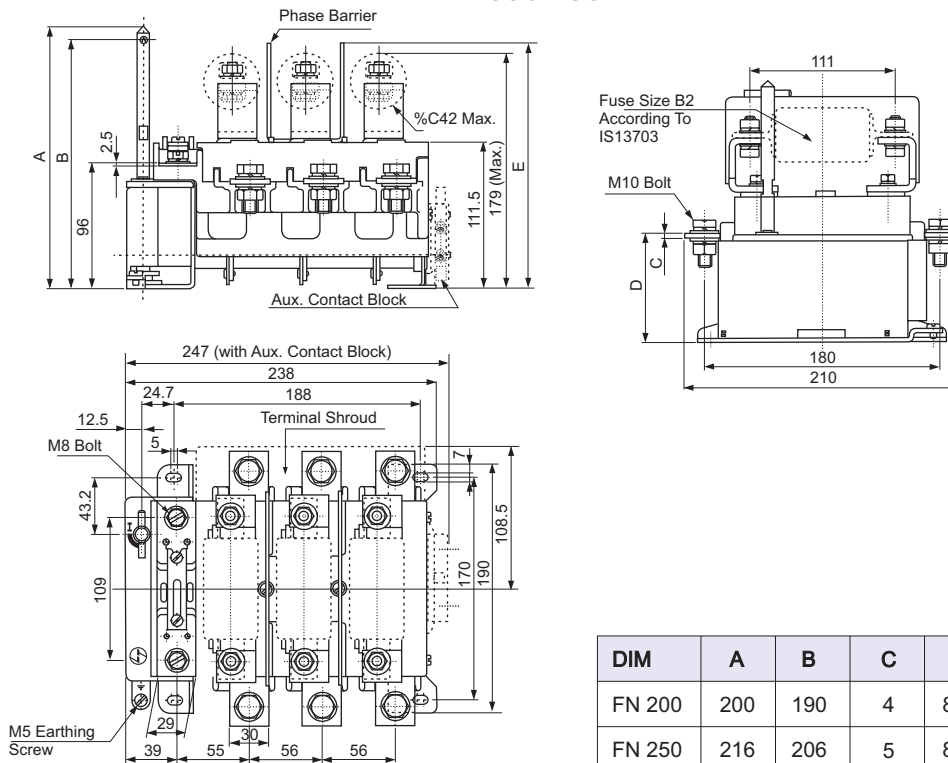

DIM	A	B	C	D	E	Fuse
FN 200	200	190	4	83.5	187.5	200 A
FN 250	216	206	5	84.5	204	250 A

Note : All dimensions are in mm.

## Switch-Disconnecter-Fuse (suitable for BS type fuses)

### FN 315 / 400

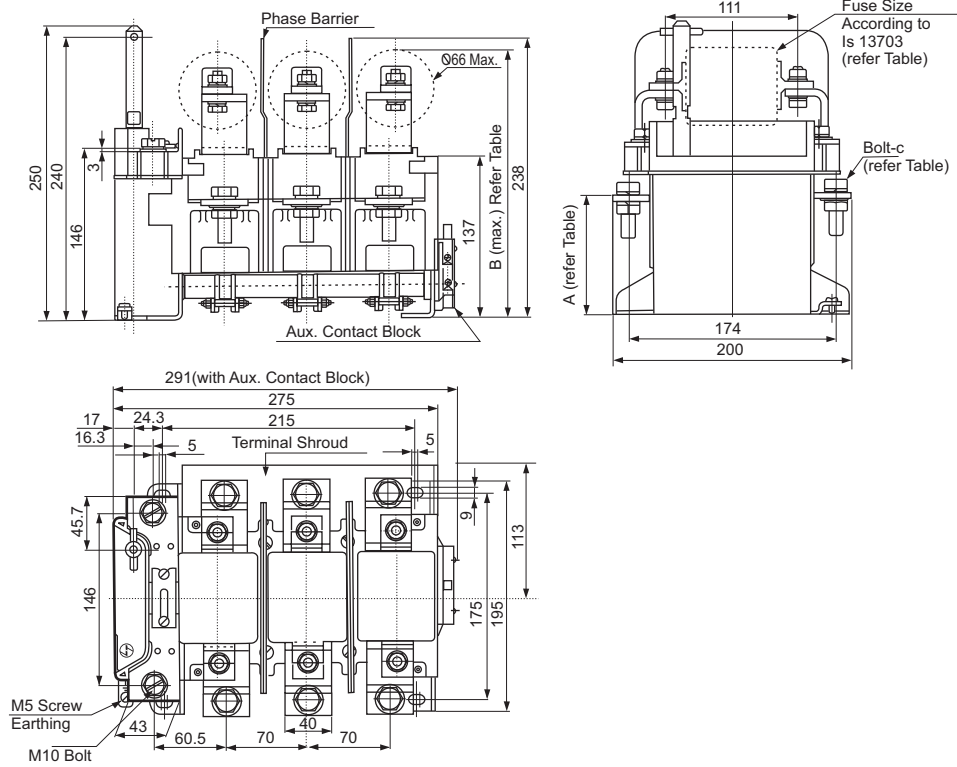

### FN 630

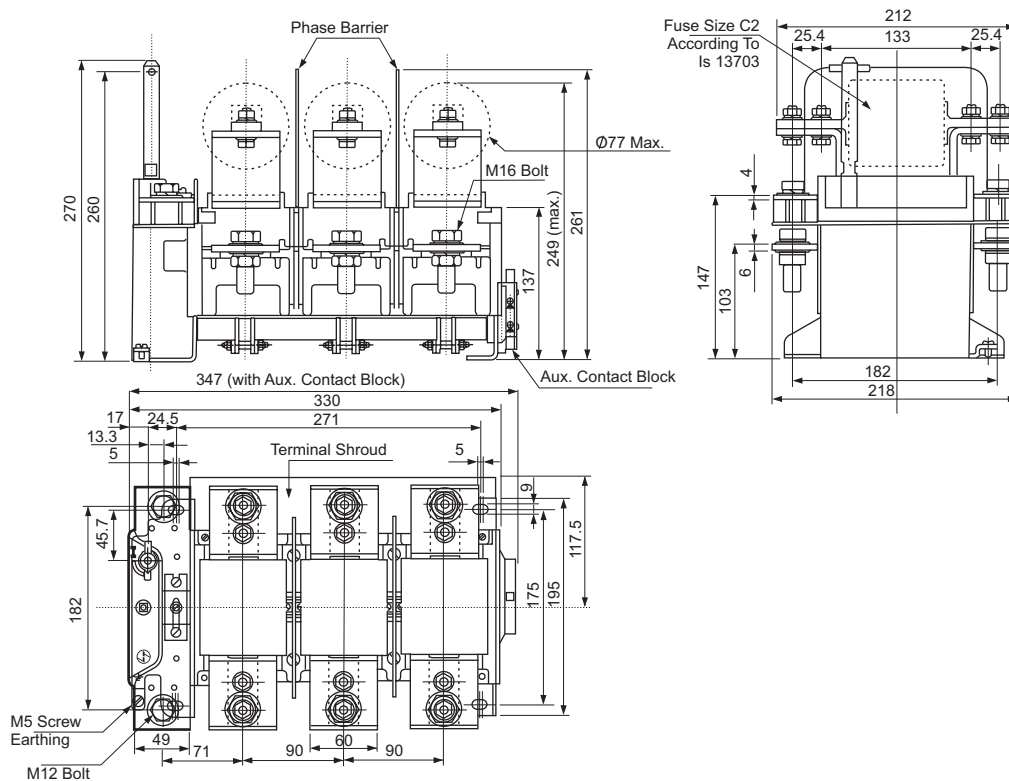

Note : All dimensions are in mm.



# HRC Fuses - Cylindrical

## Fuse Links Type HF

(Fuse links with cylindrical contact caps)

- Conforms to IEC60269 / IS13703
- Low watt loss - Saves power
- Low let through energy
- High breaking capacity - 80 kA
- Rated voltage - 415 V
- Immediate fault indication through red pop up indicator
- Lower power loss in our fuses result in cooler running of associated products



## Ordering Details

Size	Fuse Rating (A)	Cat. Nos.	Rated watt loss
14 x 51	2	SF90144	0.6
	4	SF90145	0.6
	6	SF90146	1.1
	8	SF90147	1.2
	10	SF90148	1.0
	16	SF90150	2.4
	20	SF90151	2.4
	25	SF90152	3.2
	32	SF90142	5.0
	40	SF90143	5.0
	50	SF90158	5.0
	63	SF90159	7.4

Fuse-pulling handle should be used for safe and easy removal of fuse links

Suitable fuse - pulling handle for type HF : SK91185

# HRC Fuses - Blade / Knife type

## Fuse Links Type HN

(Fuse links with blade contacts)

- Conforms to IEC60269 / IS13703
- Low watt loss - Saves power
- Cooler running of associated products
- Low let through energy
- High breaking capacity - 100 kA
- Immediate fault indication
- Rated voltage - 415 V

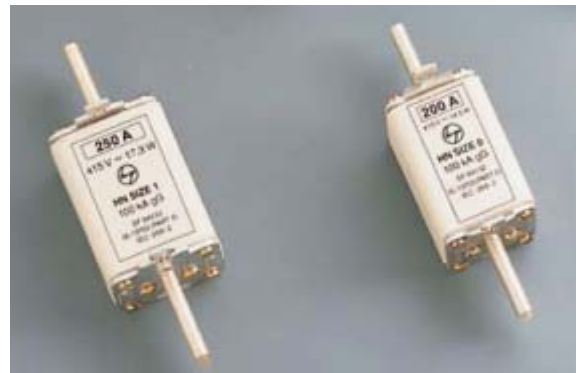

Size of the fuse link	Rating (A)	Cat. Nos.	Rated watt loss	Watt loss limits as per IS 13703
Size 000	63	SF94940	5.3	100 Amp, Fuse-7.5 W
	80	SF94941	6.2	
	100	SF94942	7	
	<b>New</b> 125	SF94946	9.5	
Size 00	63	SF94027	5.7	100 Amp, Fuse-7.5 W
	80	SF94028	6.9	
	100	SF94029	7.5	
	125	SF94030	9.8	
	160	SF94939	12	
Size 0	80	SF94128	8.3	160 Amp, Fuse-16 W
	100	SF94129	9.1	
	125	SF94130	11.3	
	160	SF94131	12.7	
	200	SF94132	14.5	
Size 1	125	SF94230	10.3	250 Amp, Fuse-23 W
	160	SF94231	12.3	
	200	SF94232	14.3	
	250	SF94233	17.3	
	315	SF94234	25.5	
Size 2	200	SF94332	14.1	400 Amp, Fuse-34 W
	250	SF94333	16.9	
	315	SF94334	20.2	
	400	SF94335	24.9	
Size 3	315	SF94434	20.5	630 Amp, Fuse-48 W
	400	SF94435	26.7	
	500	SF94436	36.1	
	630	SF94437	42.2	
	800	SF94938	48	

Fuse-pulling handle should be used for safe and easy removal of fuse links  
 Suitable fuse - pulling handle for type HN : SF90126

# HRC Fuses - Bolted

## Fuse Links Type HG and HQ

(Fuse links for bolted connections)

- Conforms to IEC60269 / IS13703
- Low watt loss
- Low let through energy
- High breaking capacity - 80kA
- Rated voltage - 415V

### Type HQ

Size of the fuse	Rating (A)	Cat. Nos.	Rated Watt Loss
A1	2	ST30736	0.3
	4	ST30737	0.5
	6	ST30738	1.2
	10	ST30739	1.4
	16	ST30740	1.8
	20	ST30741	2.2
	25	ST30742	2.9
A1L	32	ST30743	3.0
	20	ST34527	2.4
	25	ST34528	3.1
	32	ST34529	3.4
	50	ST35827	4.0
A2	63	ST35828	4.7
	4	ST30747	0.8
	6	ST30748	1.4
	10	ST30749	1.5
	16	ST30750	2.0
	20	ST30751	2.8
	25	ST30752	3.8
	32	ST30753	4.4
A3	35	ST30759	4.5
	50	ST30760	6.2
	63	ST30761	6.8
A4	80	ST30767	9.1
	100	ST30768	9.5
	125	ST30769	14
	160	ST35829	-
B1	80	ST30774	9.2
	100	ST30775	10.5
	125	ST30776	16.0
B2	125	ST30777	15.0
	160	ST30778	19.5
	200	ST30779	20.5
B3	250	ST30781	28
	315	ST30782	32
B4	355	ST30783	34
	400	ST30784	38
C2	400	ST30785	38
	500	ST30786	50
	630	ST30787	55
C3	630	ST30788	58



### Type HG

Size	Rating (A)	Cat. Nos.	Rated Watt Loss
F1	2	ST30725	0.3
F1	4	ST30726	0.5
F1	6	ST30727	1.2
F1	10	ST30728	1.4
F1	16	ST30729	1.8
F1	20	ST30730	2.2
F1	25	ST30731	2.9
F1	32	ST30732	3.0



## Electrical Standard Products (ESP) Branch Offices:

### REGISTERED OFFICE AND HEAD OFFICE

L&T House, Ballard Estate  
P. O. Box 278  
**Mumbai 400 001**  
Tel: 022-67525656  
Fax: 022-67525858  
Website: www.Larsentoubro.com

### ELECTRICAL STANDARD PRODUCTS (ESP)

501, Sakar Complex I  
Opp. Gandhigram Rly. Station  
Ashram Road  
**Ahmedabad 380 009**  
Tel: 079-66304006-11  
Fax: 079-66304025  
e-mail: esp-ahm@LNTEBG.com

38, Cubbon Road, P. O. Box 5098  
**Bangalore 560 001**  
Tel: 080-25020100 / 25020324  
Fax: 080-25580525  
e-mail: esp-blr@LNTEBG.com

131/1, Zone II  
Maharana Pratap Nagar  
**Bhopal 462 011**  
Tel: 0755-4098721 / 7 / 8 / 9  
Fax: 0755-2769264  
e-mail: esp-bho@LNTEBG.com

Plot No. 559, Annapura Complex  
Lewis Road  
**Bhubaneswar 751 014**  
Tel: 0674-6451342, 2436696  
Fax: 0674-2537309  
e-mail: esp-bbi@LNTEBG.com

SCO 32, Sector 26-D  
Madhya Marg, P. O. Box 14  
**Chandigarh 160 026**  
Tel: 0172-4646840, 4646853  
Fax: 0172-4646802  
e-mail: esp-chd@LNTEBG.com

L&T Construction Campus  
TC-1 Building, II Floor  
Mount-Poonamallee Road  
Manapakkam  
**Chennai 600 089**  
Tel: 044-2270 6800  
Fax: 044-22706940  
e-mail: esp-maa1@LNTEBG.com

67, Appuswamy Road  
Post Bag 7156  
Opp. Nirmala College  
**Coimbatore 641 045**  
Tel: 0422-2588120 / 1 / 5  
Fax: 0422-2588148  
e-mail: esp-cbe@LNTEBG.com

Crystal Tower, Plot No. 606/1  
4th Floor, G. E. Road  
Telibandha  
**Raipur - 492 006**  
Tel: 0771-4283216/224  
e-mail: esp-raipur@LNTEBG.com

Khairasol, Degaul Avenue  
**Durgapur 713 212**  
Tel: 2559848, 2559849, 2559844  
Fax: 0343-2553614  
e-mail: esp-dgp@LNTEBG.com

Milanpur Road, Bamuni Maidan  
**Guwahati 781 021**  
Tel: 0361-2550562 / 65  
Fax: 0361-2551308  
e-mail: hazrasudipto@LNTEBG.com

II Floor, Vasantha Chambers  
5-10-173, Fateh Maidan Road  
**Hyderabad 500 004**  
Tel: 040-67015052  
Fax: 040-23296468  
e-mail: esp-hyd@LNTEBG.com

Monarch Building, 1st Floor  
D-236 & 237, Amrapali Road  
Vaishali Nagar  
**Jaipur 302 021**  
Tel: 0141-4385914 / 18  
Fax: 0141-4385925  
e-mail: esp-jai@LNTEBG.com

Akashdeep Plaza, 2nd Floor  
P. O. Golmuri  
**Jamshedpur 831 003**  
Jharkhand  
Tel: 0657-2312205 / 38  
Fax: 0657-2341250  
e-mail: esp-jam@LNTEBG.com

Skybright Bldg; M. G. Road  
Ravipuram Junction, Ernakulam  
**Kochi 682 016**  
Tel: 0484-4409420 / 4 / 5 / 7  
Fax: 0484-4409426  
e-mail: esp-cok@LNTEBG.com

3-B, Shakespeare Sarani  
**Kolkata 700 071**  
Tel: 033-44002572 / 3 / 4  
Fax: 033-22821025 / 7587  
e-mail: esp-ccu@LNTEBG.com

A28, Indira Nagar, Faizabad Road  
**Lucknow 226 016**  
Tel: 0522-2312904 / 5 / 6  
Fax: 0522-2311671  
e-mail: esp-Lko@LNTEBG.com

No: 73, Karpaga Nagar, 8th Street  
K. Pudur  
**Madurai 625 007**  
Tel: 0452-2537404, 2521068  
Fax: 0452-2537552  
e-mail: esp-mdu@LNTEBG.com

EBG North Wing Office-Level 2  
Gate 7, Powai Campus  
**Mumbai 400 072**  
Tel: 022-67052874 / 2737 / 1156  
Fax: 022-67051112  
e-mail: esp-bom@LNTEBG.com

12, Shivaji Nagar  
North Ambazari Road  
**Nagpur 440 010**  
Tel: 0712-2260012 / 3  
Fax: 0712-2260020 / 30  
e-mail: esp-nag@LNTEBG.com

32, Shivaji Marg  
P. O. Box 6223  
**New Delhi 110 015**  
Tel: 011-41419514 / 5 / 6  
Fax: 011-41419600  
e-mail: esp-del@LNTEBG.com

L&T House  
P. O. Box 119  
191/1, Dhole Patil Road  
**Pune 411 001**  
Tel: 020-26135048 / 26164048  
Fax: 020-26124910, 26135048  
e-mail: esp-pnq@LNTEBG.com

3rd Floor  
Vishwakarma Chambers  
Majura Gate, Ring Road  
**Surat 395 002**  
Tel: 0261-2473726  
Fax: 0261-2477078  
e-mail: esp-sur@LNTEBG.com

Radhadaya Complex  
Old Padra Road  
Near Charotar Society  
**Vadodara 390 007**  
Tel: 0265-6613610 / 1 / 2  
Fax: 0265-2336184  
e-mail: esp-bar@LNTEBG.com

48-8-16, Dwarakanagar  
**Visakhapatnam 530 016**  
Tel: 0891-670 1125 to 1130  
Fax: 0891- 670 1139  
e-mail: esp-viz@LNTEBG.com

Product improvement is a continuous process. For the latest information and special applications, please contact any of our offices listed here.



Larsen & Toubro Limited  
Electrical Standard Products  
Powai Campus, Mumbai 400 072  
**Customer Interaction Center (CIC)**  
BSNL / MTNL (toll free) : 1800 233 5858  
Reliance (toll free) : 1800 200 5858  
Tel : 022 6774 5858, Fax : 022 6774 5859  
E-mail : cic@LNTEBG.com  
Website : www.LNTEBG.com